



Pumice & Blend D



Cafe & Blend C

## TECHNICAL SPECIFICATIONS

Technical Characteristics	ASTM Test Result	ASTM/ANSI Test Method
Water Absorption %	≥10%	A 187.1
Dimensionality (flatness, warpage, straightness, etc.)	premium grade conformance	A 187.1 ISO 10545-2
Thermal Shock & Cracking Resistance	Pass	A 187.1 ISO 10545-9/11
Resistance to Stains, chemicals acids, etc.	Pass	C650 & C1378 ISO 10545-13/14

## PACKAGING

Size	PC/CTN	Sqft/ctn (Sqm/ctn)	Carton/Pallet	Sqft/plt (Sqm/plt)	Lbs/ctn (Kgs/ctn)	Lbs/plt (Kgs/plt)
3x6" (76x152)	72	8.96 (0.83)	90	806.31 (74.91)	34.17 (15.50)	3,075.45 (1,395.00)
4x16" (100x402)	25	10.76 (1.00)	70	753.48 (70.00)	36.38 (16.50)	2,546.34 (1,155.00)
mosaic 1x1" (300x300)	11	10.76 (1.00)	54	581.26 (54.00)	45.19 (20.50)	2,440.52 (1,107.00)

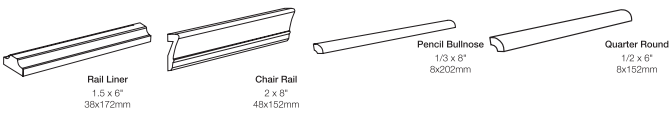

\*Outside corner pieces available for all trims. Pencil Bullnose and Quarter Round are universal trims and will not feature H-Line labeling. For more information on Bellavita Trims and uses, please visit our website.

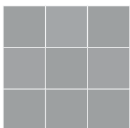

V1

Minimal Variation

### COTTON



HLCO36 | HLCO416

### COTTON MATTE



HLCOM36 | HLCOM416

### ALABASTER



HLAL36 | HLAL416

### ALABASTER MATTE

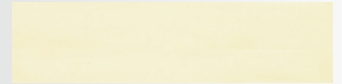

HLALM36 | HLALM416

### STRAW



HLST36 | HLST416

### DENIM



HLDE36 | HLDE416

### NAUTILUS



HLNA36 | HLNA416

### PUMICE



HLPU36 | HLPU416

### CAFE

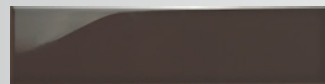

HLCA36 | HLCA416

### PEARL

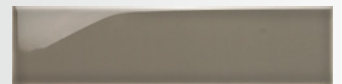

HLPE36 | HLPE416

### MOSAICS

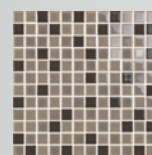

HL11MOS-A

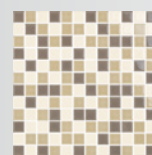

HL11MOS-B

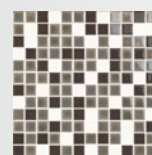

HL11MOS-C

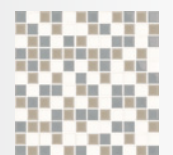

HL11MOS-D



Pearl & Blend B

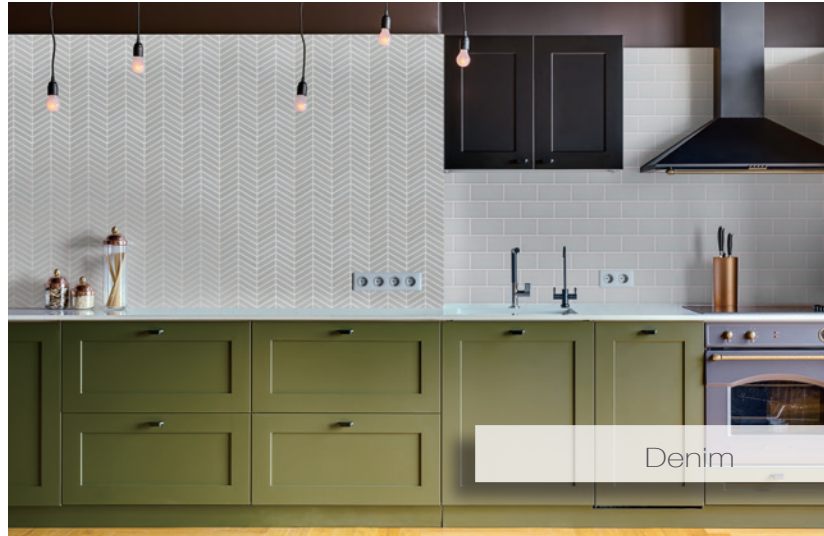

Denim

## TECHNICAL SPECIFICATIONS

Technical Characteristics	ASTM Test Result	ASTM/ANSI Test Method
Water Absorption %	≥10%	A 187.1
Dimensionality (flatness, warpage, straightness, etc.)	premium grade conformance	A 187.1 ISO 10545-2
Thermal Shock & Cracking Resistance	Pass	A 187.1 ISO 10545-9/11
Resistance to Stains, chemicals acids, etc.	Pass	C650 & C1378 ISO 10545-13/14

## PACKAGING

Size	PC/CTN	Sqft/ctn (Sqm/ctn)	Carton/Pallet	Sqft/plt (Sqm/plt)	Lbs/ctn (Kgs/ctn)	Lbs/plt (Kgs/plt)
12x9" (310x240)	10	7.21 (0.67)	72	519.26 (48.24)	20.83 (9.45)	1,500.03 (680.40)

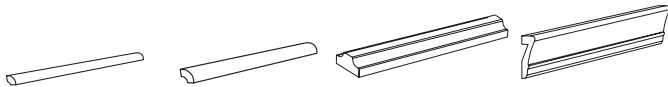

Pencil Bullnose, Quarter Round, Rail Liner and Chair Rail available in all colors. Visit our website for further details

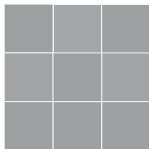

**V1**  
Minimal

## chevron

### H-Line Colors



Cotton | CHEV129CO

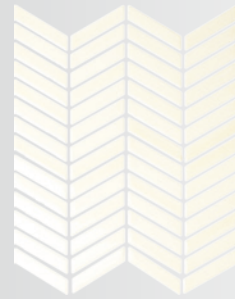

Alabaster | CHEV129AL

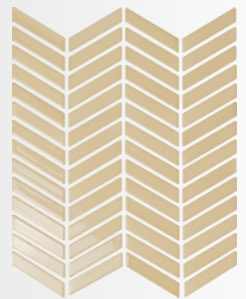

Straw | CHEV129ST



Pumice | CHEV129PU



Nautilus | CHEV129NA

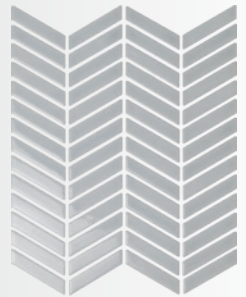

Denim | CHEV129DE



Pearl | CHEV129PE



Cafe | CHEV129CA

Cotton and Alabaster colors also available in matte\*\*\*

# Casabella<sup>®</sup> Ceramic

## H-LINE Ceramic Wall Tile



Item Used: HLDE36H & HLDE416

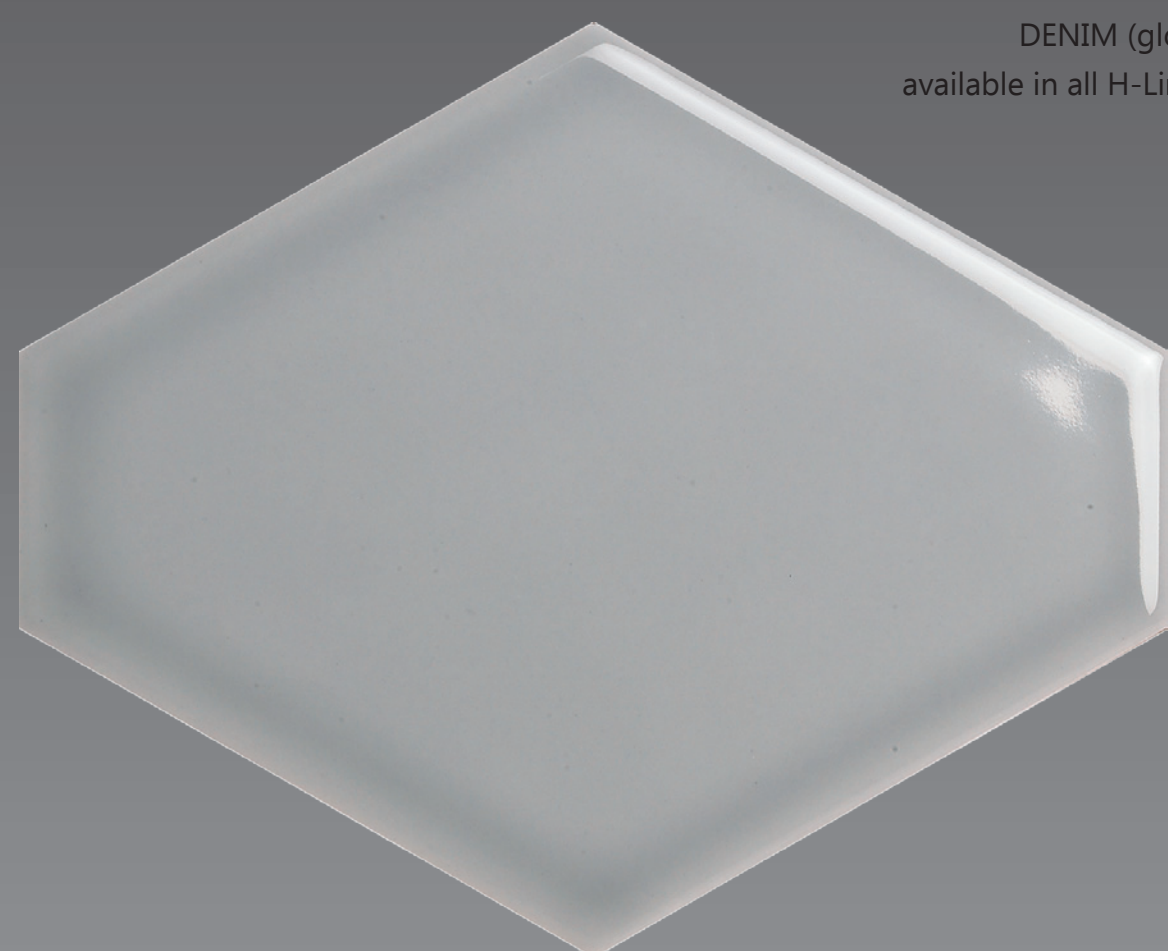

DENIM (glossy) 4x6  
available in all H-Line colors



DENIM (glossy) Chevron 12x9  
available in all H-Line colors

BLEND-D (glossy) 12x11  
available in 4 custom blends

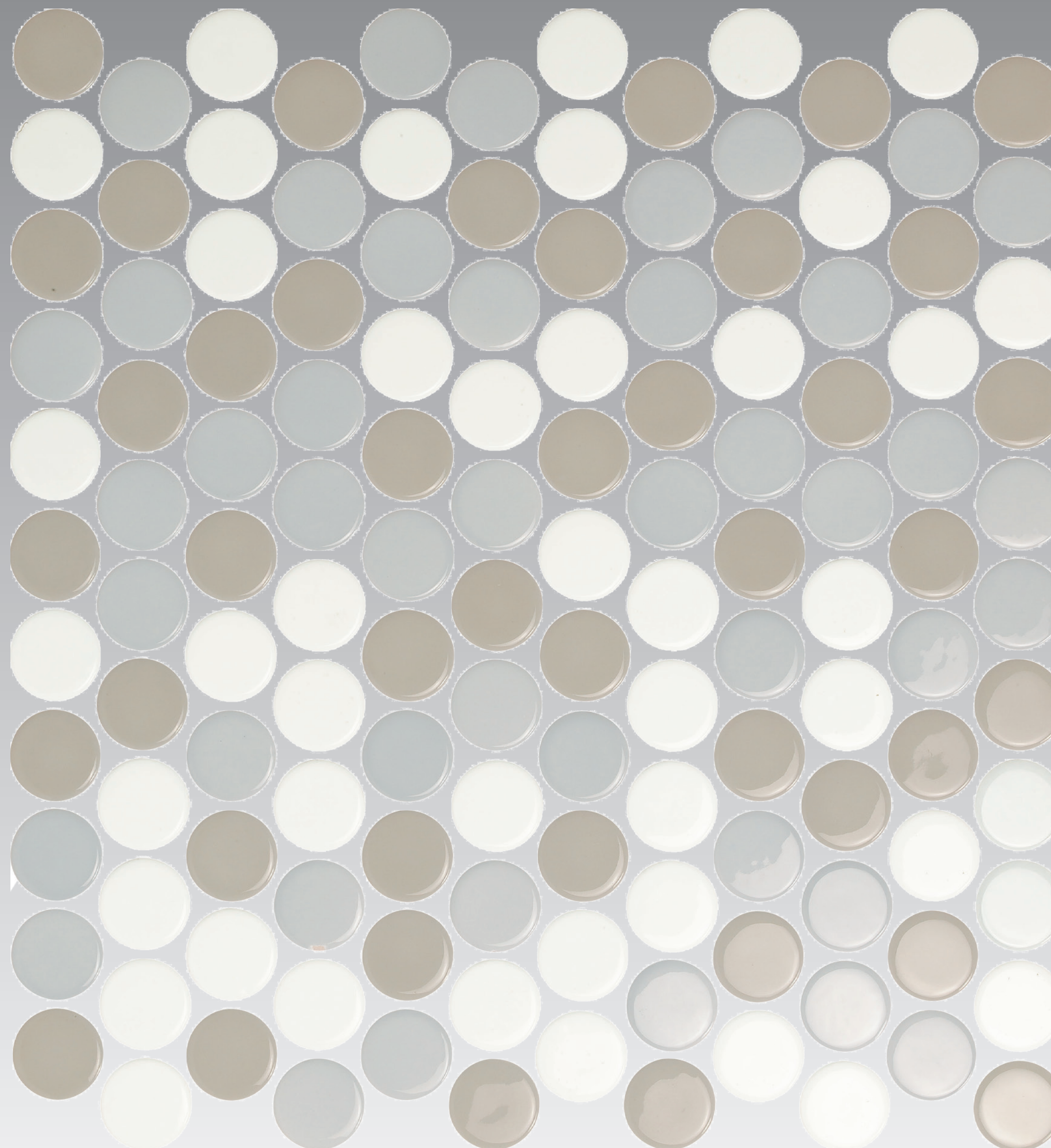

### AVAILABLE SIZES

4" x 16"

3" x 6"

4.75" x 6"  
Hexagon

*Ceramic Wall Tile For A Beautiful Home*

Finished Board Item #: HBATHLSET2

# Casabella<sup>®</sup> Ceramic

## H-LINE Ceramic Wall Tile

AVAILABLE SIZES

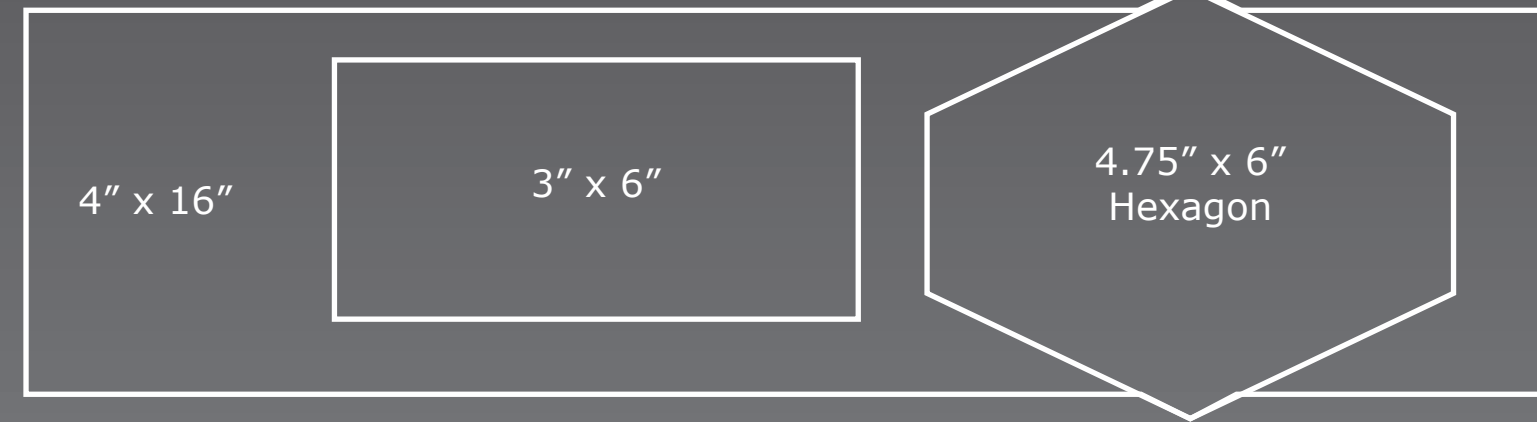

Item Used: HLMO11-C | HLCO416 | RL16WH02GO



DENIM (glossy) 4x16 - Also available in 3x6

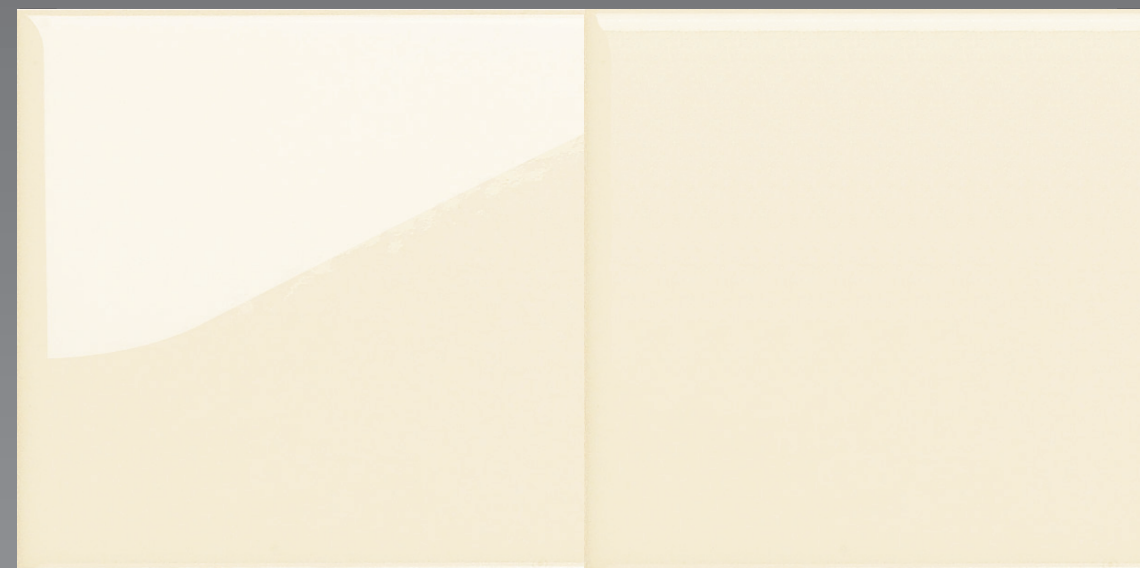

ALABASTER (glossy) 3x6  
Also available in 4x16

ALABASTER (matte) 3x6  
Also available in 4x16



COTTON (glossy) 3x6  
Also available in 4x16

COTTON (matte) 3x6  
Also available in 4x16

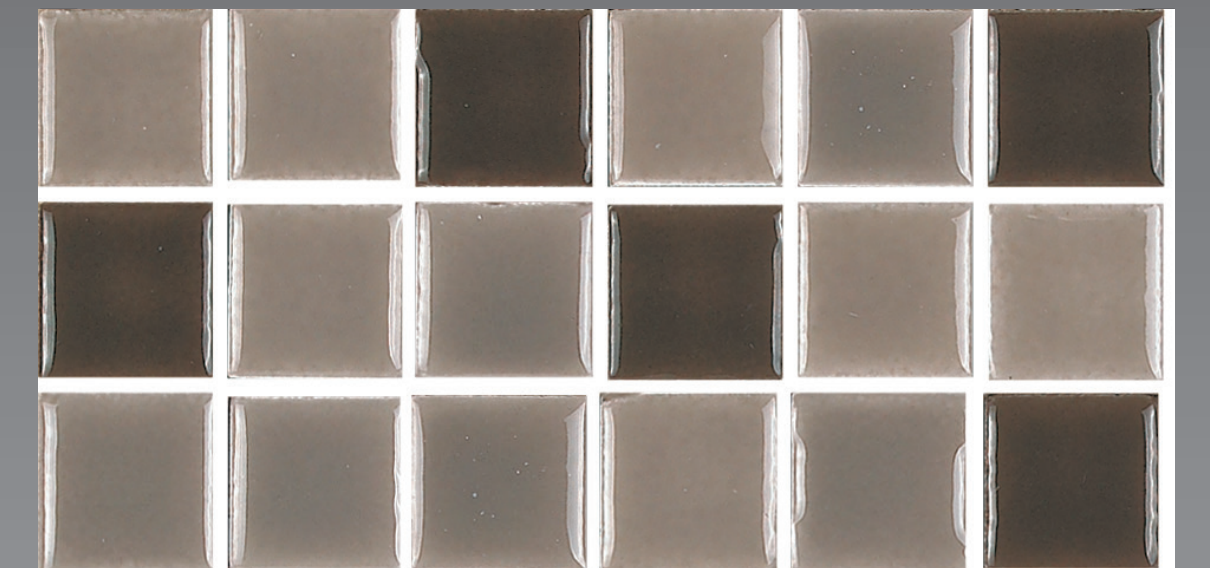

1x1 Mosaics  
Blend "A"



NAUTILUS (glossy) 3x6  
Also available in 4x16



PEARL (glossy) 3x6  
Also available in 4x16



1x1 Mosaics  
Blend "B"



STRAW (glossy) 3x6  
Also available in 4x16



PUMICE (glossy) 3x6  
Also available in 4x16

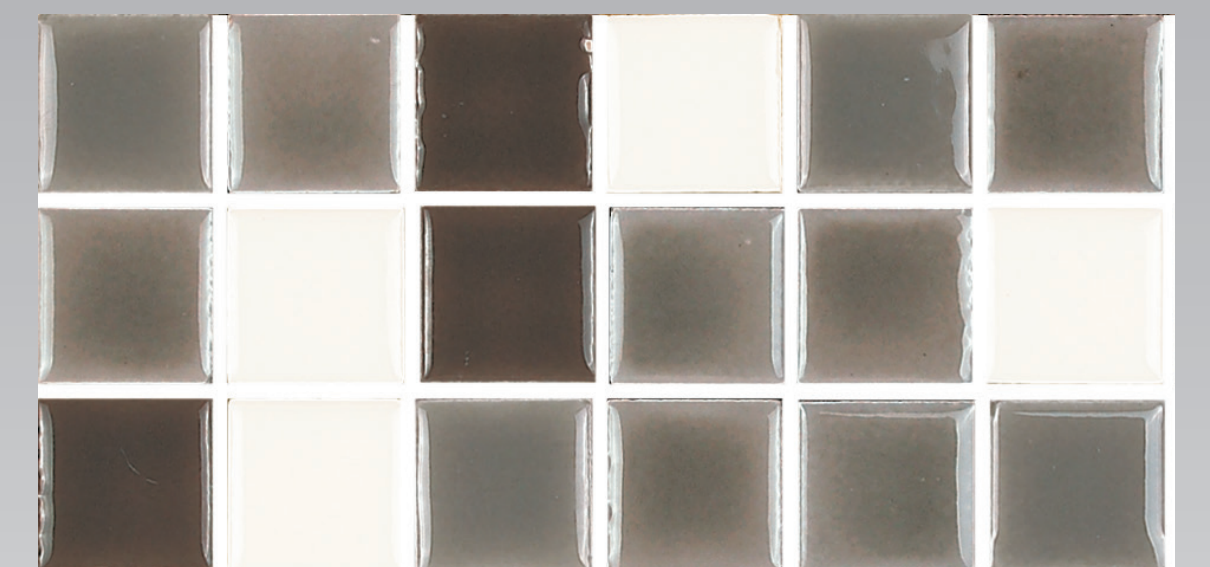

1x1 Mosaics  
Blend "C"



CAFE (glossy) 3x6  
Also available in 4x16

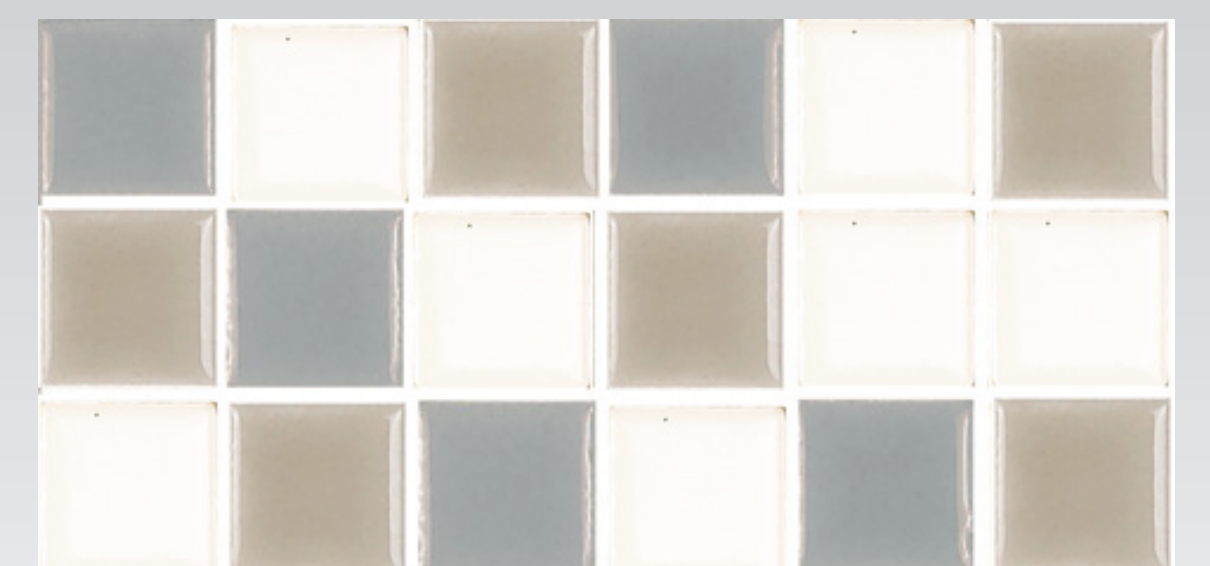

1x1 Mosaics  
Blend "D"

*Ceramic Wall Tile For A Beautiful Home*

Finished Board Item #: HBATHLSET1

# Casabella<sup>®</sup> Ceramic

## H-LINE Ceramic Wall Tile



Item Used: HLPE36 | HLMO11-A

### INSTALLATION & MAINTENANCE

- Ceramic wall tile is suitable for all interior wall or ceiling applications including wet areas. Not suitable for demanding environments such as steam showers.
- All products should be inspected prior to installation for any defects or unacceptable color/shade variation. Claims will not be accepted after installation.
- Proper substrates, preparation and installation materials are required for a successful installation. For reference please see the TCNA 09300 Tile Handbook.
- Non sanded grouts are recommended for high gloss wall tiles.
- Ensure all grout haze is buffed off before 48 hours have elapsed after installation.
- Glazed tile should not be treated with a sealer for any reason.
- To clean glazed ceramic wall tile, use a damp sponge with warm water. For heavy cleaning, use a non-abrasive cleaner with a damp sponge.
- Further warranty, best practices, care and maintenance details can be found on our website.

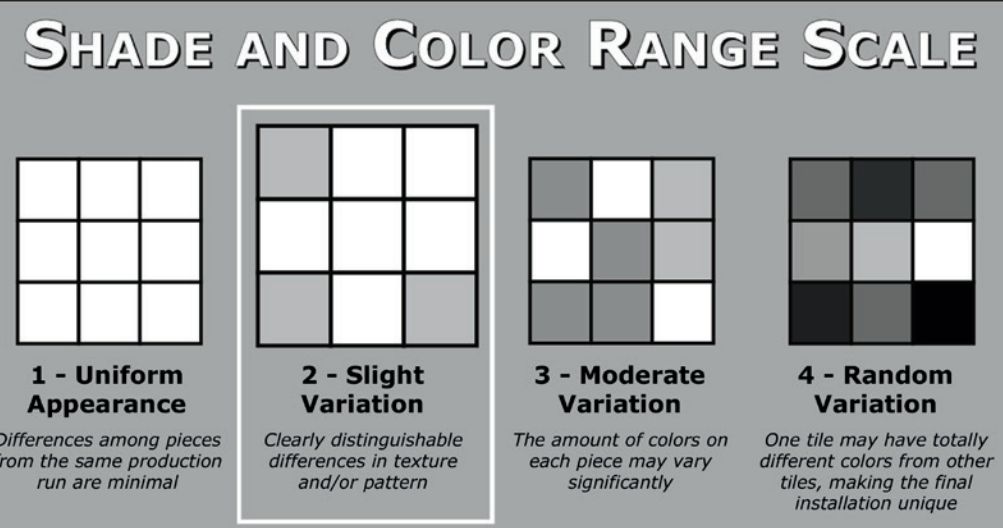

*Just as High Lines and elevated rail brought underground transport into the future - H-Line Collection breathes new life into the traditional subway tile.*

*The ultra-glossy translucent glaze adds an unparalleled level of depth and sophistication through variation of tone.*

*Offered in two formats, a wide array of colors, multiple trims and an array of blended mosaics - H-Line Collection is the perfect neutral yet dynamic canvas for timeless design.*

### TECHNICAL SPECIFICATIONS

Technical Characteristics	ASTM Test Result	ASTM/ANSI Test Method
Water Absorption %	<10%	A 187.1
Dimensionality (flatness, warpage, straightness, etc.)	premium grade conformance	A 187.1 ISO 10545-2
Thermal Shock & Cracking Resistance	Pass	A 187.1 ISO 10545-9/11
Resistance to Stains, chemicals, acids, etc.	Pass	ISO 10545-13/14

### SUGGESTED USES

- Suitable for all wall applications including wet areas. Not for demanding environments such as steam showers.
- Suitable for columns when used vertically.
- Suitable for interior applications ONLY.

Application	Residential	Commercial	Industrial
Floors			
Wall & Backsplash	✓	✓	✓
Counters	✓		
Pool (Vertical only)			

### FORMATS

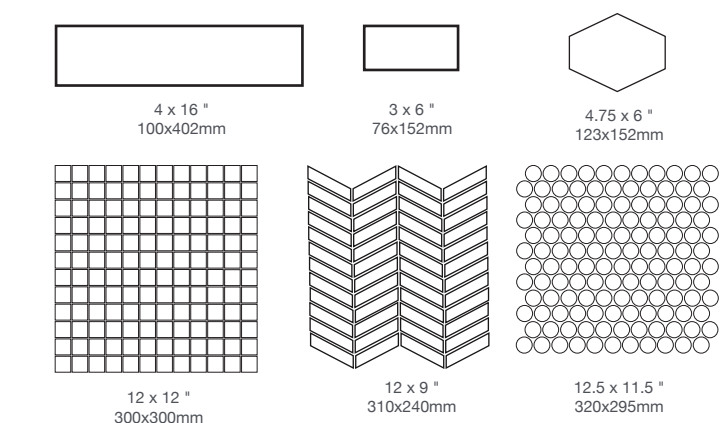

### ALABASTER GLOSSY

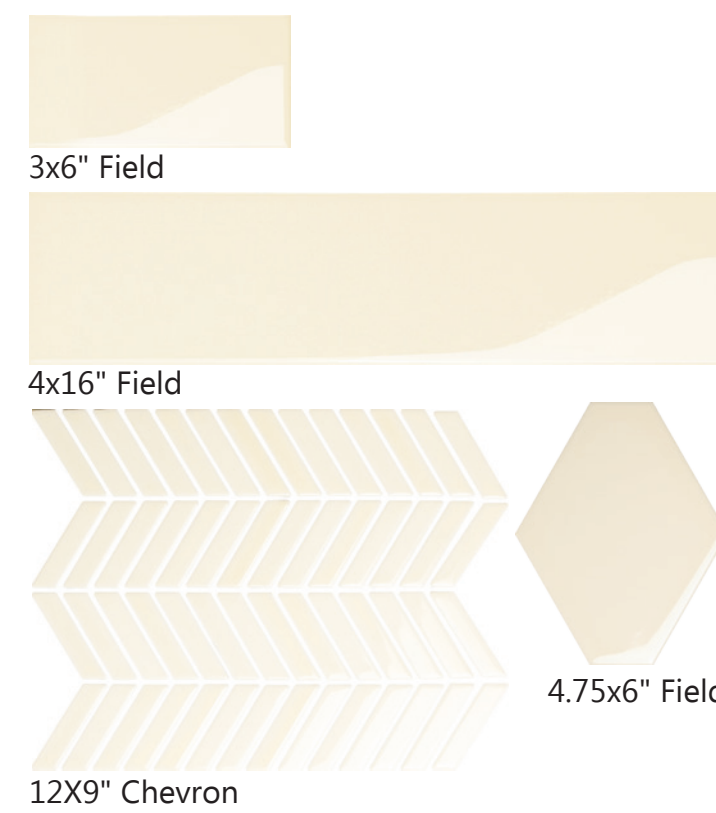

### ALABASTER MATTE

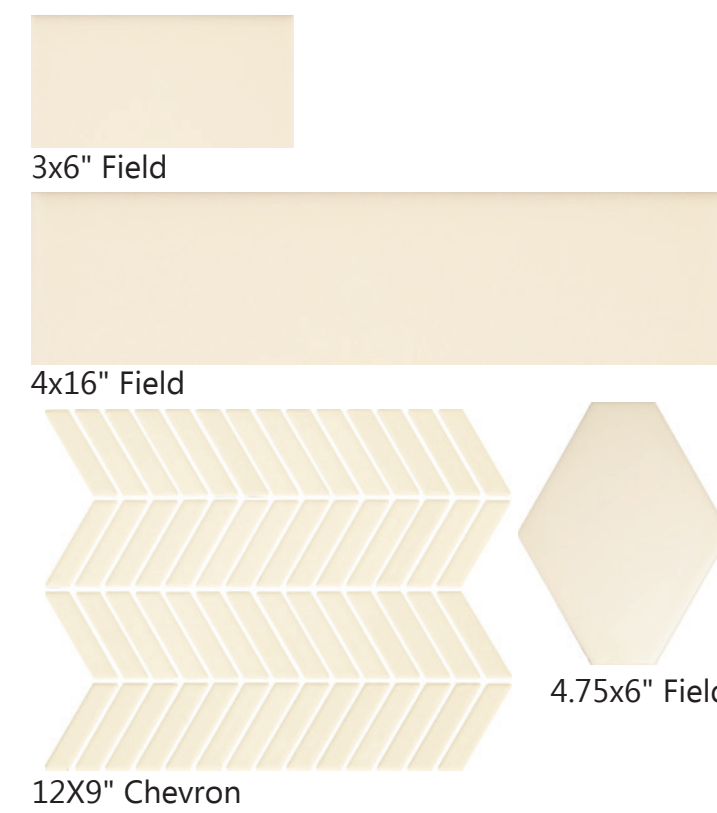

### CAFE GLOSSY

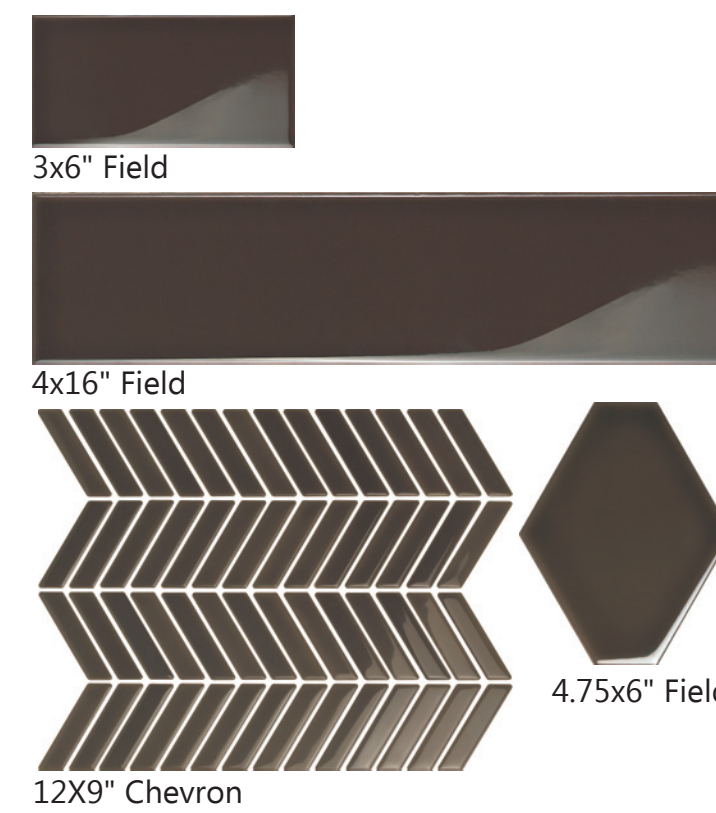

### COTTON GLOSSY

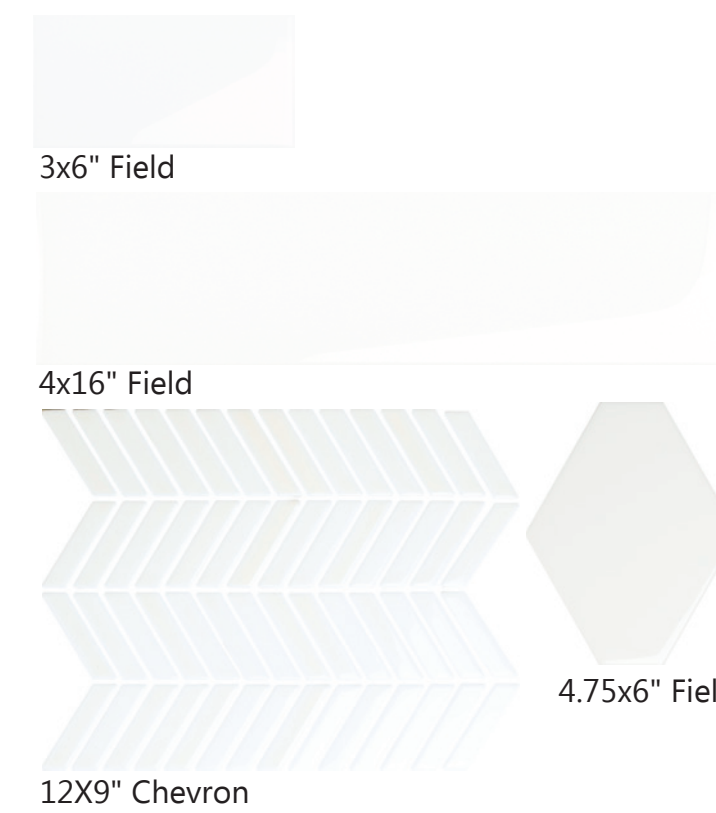

### COTTON MATTE

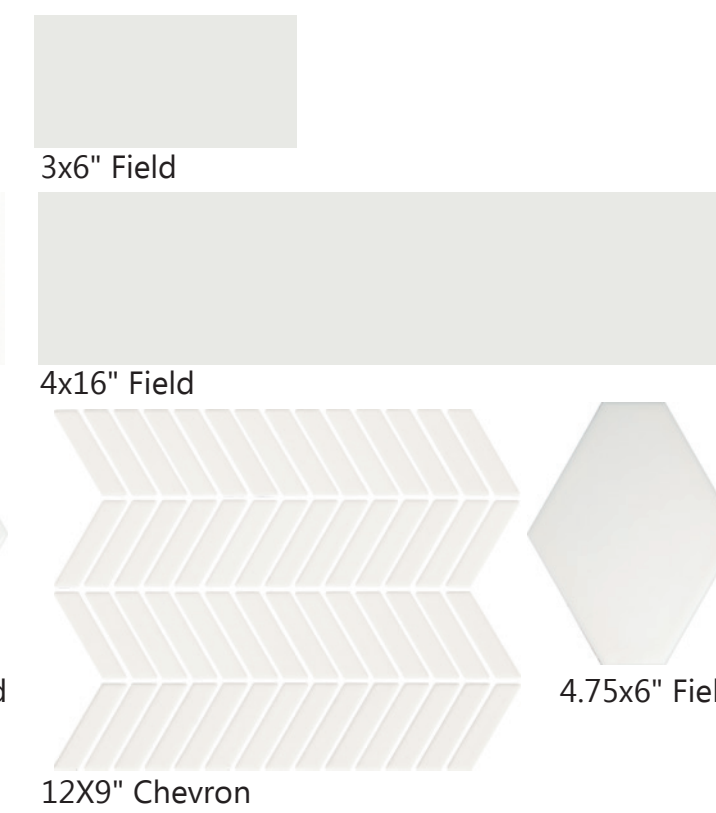

### DENIM GLOSSY

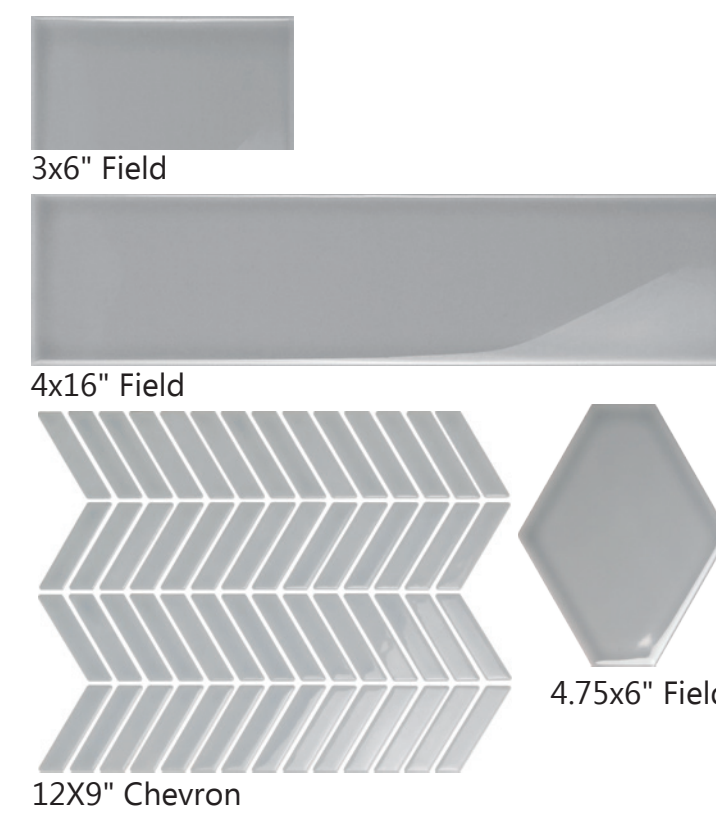

### NAUTILUS GLOSSY

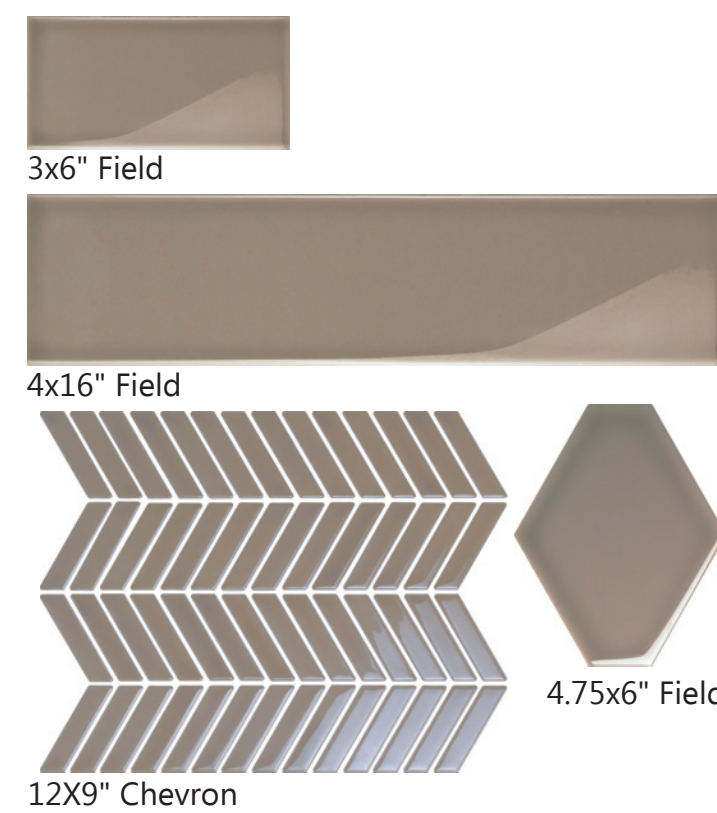

### PEARL GLOSSY

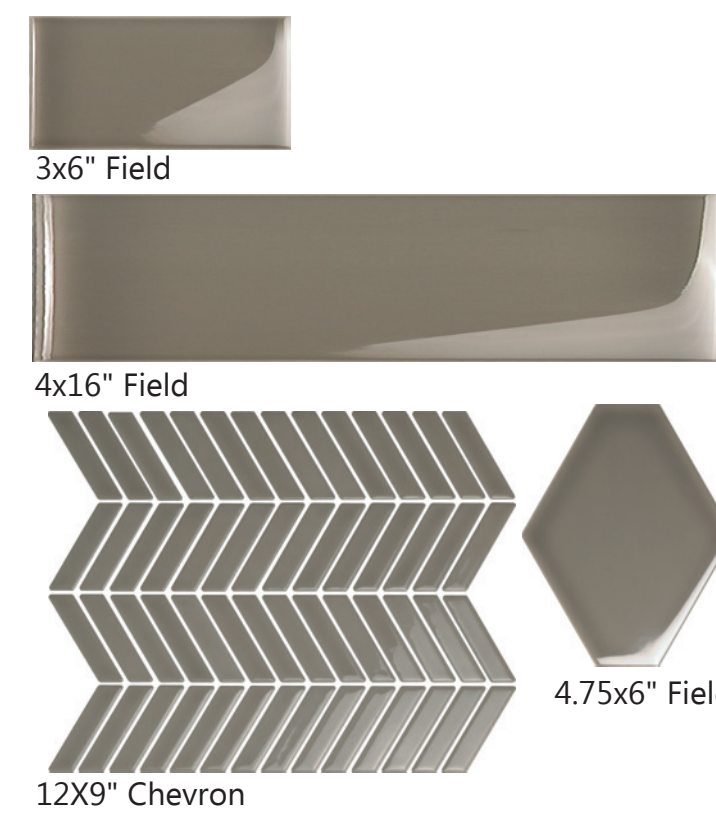

### PUMICE GLOSSY

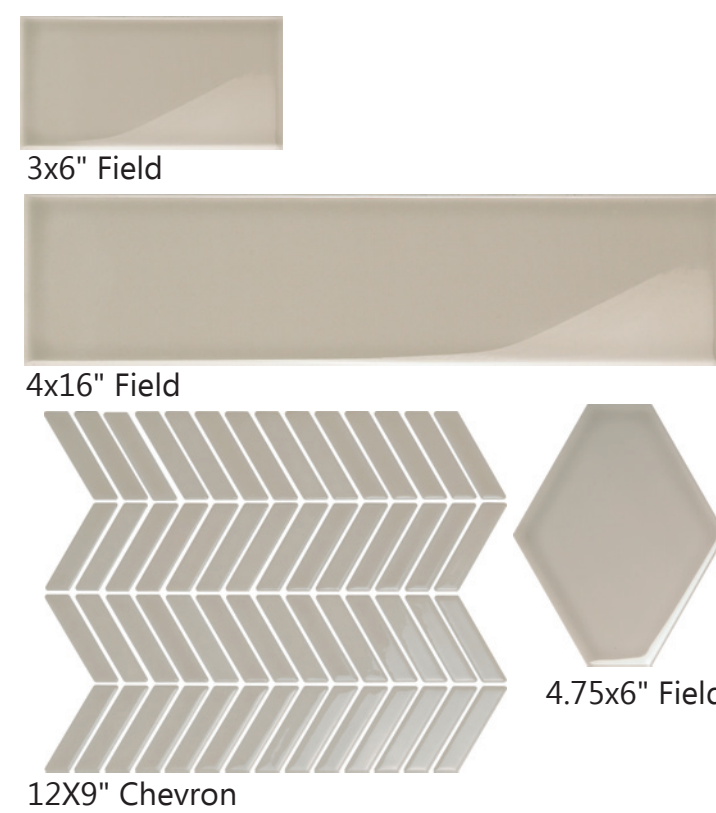

### STRAW GLOSSY

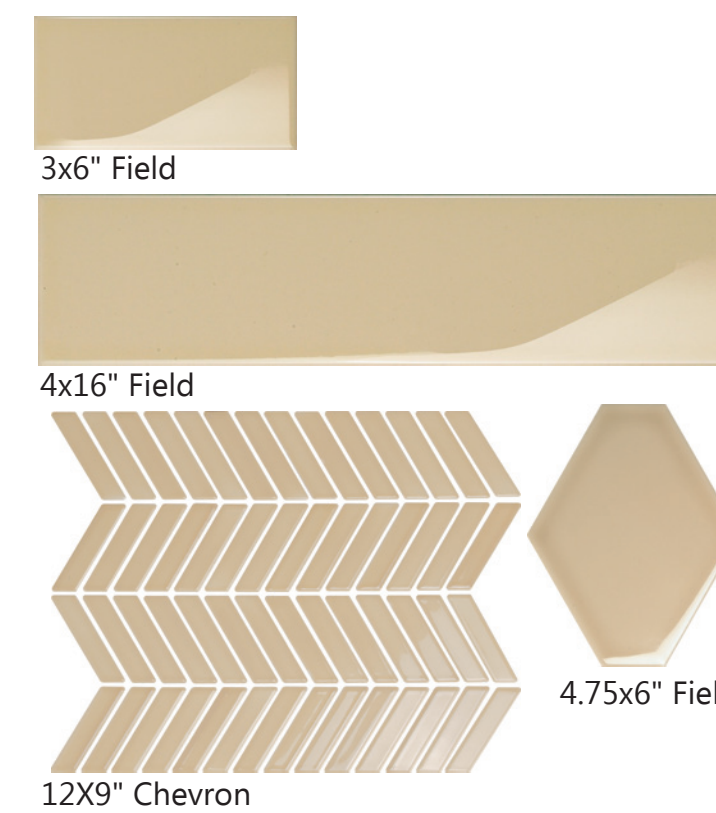

### TRIMS

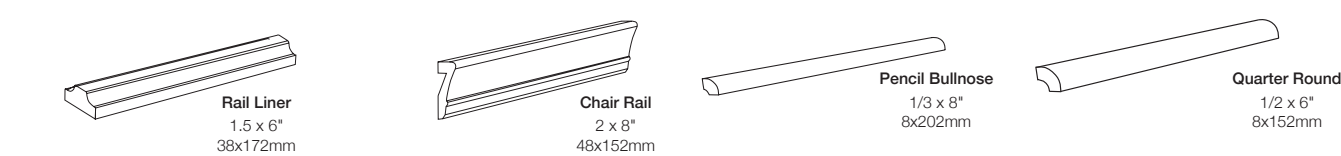

\*Outside corner pieces available for all trims. Pencil Bullnose and Quarter Round are universal trims and will not feature H-Line labeling. For more information on Bellavita Trims and uses, please visit our website.

### ITEM CODES

Format	Cotton	Cotton Matte	Alabaster	Alabaster Matte	Straw	Nautilus	Pearl	Pumice	Denim	Cafe	Blend A	Blend B	Blend C	Blend D
3x6"	HLCO36	HLCOM36	HLAL36	HLALM36	HLST36	HLNA36	HLPE36	HLPU36	HLDE36	HLCA36	---	---	---	---
4x16"	HLCO416	HLCOM416	HLAL416	HLALM416	HLST416	HLNA416	HLPE416	HLPU416	HLDE416	HLCA416	---	---	---	---
hex 4.75x6"	HLAC6CH	HLAC6CMH	HLAS6H	HLAS6MH	HLAS6TH	HLAS6NH	HLAS6PH	HLAS6PH	HLAS6EH	HLAS6CH	---	---	---	---
1x1" Mosaic	---	---	---	---	---	---	---	---	---	---	HLMO11-A	HLMO11-B	HLMO11-C	HLMO11-D
Chevron Mosaic	CHEV129CO	CHEV129COM	CHEV129AL	CHEV129ALM	CHEV129ST	CHEV129NA	CHEV129PE	CHEV129PU	CHEV129DE	CHEV129CA	---	---	---	---
Penny Round Mosaic	POPI211CO	---	---	---	---	---	---	POPI211PU	---	---	POPI211-A	POPI211-B	POPI211-C	POPI211-D
Rail Liner	RL18WHK20G	RL18WHK30G	RL18CRK20G	RL18CRK30G	RL18STK20G	RL18STK30G	RL18PEK20G	RL18PEK30G	RL18DEK20G	RL18DEK30G	---	---	---	---
Chair Rail	CR18WHK20G	CR18WHK30G	CR18CRK20G	CR18CRK30G	CR18STK20G	CR18STK30G	CR18PEK20G	CR18PEK30G	CR18DEK20G	CR18DEK30G	---	---	---	---
Pencil Bullnose	PB18WHK20G	PB18WHK30G	PB18CRK20G	PB18CRK30G	PB18STK20G	PB18STK30G	PB18PEK20G	PB18PEK30G	PB18DEK20G	PB18DEK30G	---	---	---	---
Quarter Round	QR18WHK20G	QR18WHK30G	QR18CRK20G	QR18CRK30G	QR18STK20G	QR18STK30G	QR18PEK20G	QR18PEK30G	QR18DEK20G	QR18DEK30G	---	---	---	---

### MOSAIC BLENDS

