

INSTALLATION INSTRUCTIONS FOR ENGINEERED TONGUE & GROOVE HARDWOOD FLOORING

Casabella®
Hardwood

Enclosed you will find installation instructions for the following products: Engineered Tongue & Groove (T&G) Hardwood

ATTENTION! READ BEFORE INSTALLING!

Before starting installation, read all instructions thoroughly. Should any questions arise, please contact your local dealer. All installation instructions must be followed for warranties to be considered valid.

Pre-inspect the job site prior to delivery of the floor to ensure the structure is suitable for hardwood flooring installation using the following guidelines:

OWNER/INSTALLER RESPONSIBILITY

1. Inspect the hardwood flooring in well lighted conditions to ensure proper identification of any potential problems. Carefully inspect the flooring for grade, color, finish, and quality. Material that is subjectively viewed as unacceptable but falls within Manufacturer grading norms will not be replaced. Material with visible defects can be returned for replacement through the dealer.
2. Inspect the hardwood flooring in well lighted conditions to ensure proper identification of any potential problems. Carefully inspect the flooring for grade, for color, finish, and quality. If the flooring is not acceptable, contact Manufacturer and arrange shipment of replacement material. Defective product will be replaced. Material that is subjectively viewed as unacceptable but falls within Manufacturer' grading norms will not be replaced. Once flooring is installed, deemed acceptable by Enduser/ Homeowner/Contractor.
3. Prior to installation of any flooring, the Installer must ensure the job site and sub-floor conditions meet the requirements specified in these instructions.
4. Hardwood flooring installation should be one of the last items completed on the construction project. Limit foot traffic on the finished wood floor.

GRADING STANDARDS

GENERAL RULES:

Flooring shall be tongue and grooved and end matched (unless otherwise indicated). Flooring shall not be considered of standard grade unless properly dried.

GRADING RULES:

Like many flooring and lumber mills, we use a proprietary grade for manufacturing our floors. Proprietary grades are generally referred to as Mill Run. Instead of separating the lumber into traditional NOFMA/NWFA grades, the flooring is a mix of grades. This enables us to produce wider and longer boards. Manufacturer grading rules allow for filled knots, mineral streak, open checks, tight checks, and filled checks. Bird peck, pin worm hole,

and flag worm hole are acceptable (any insects are killed in drying process). Plank faces may also contain unlimited amounts of heart wood (dark portion of log) and/or sap wood (light portion of log).

ENVIRONMENTAL ISSUES

Damage caused by inappropriate handling, environment, installation, or maintenance issues will not be considered in relationship to grade. **NOTE: DO NOT OPEN BOXES PRIOR TO INSTALLATION.** Boxes to remain completely closed until time of installation.

STORAGE AND HANDLING

Handle and unload wood flooring with care. Store in a dry place; Make sure to provide at least a four-inch space (using dry 4" x 4" stickers or a dry pallet that provides enough clearance under boxes for proper air movement. Prior to delivery of flooring, outside doors and windows must be in place.

All concrete, masonry, plastering, and other "wet" work must be complete and thoroughly dry prior to flooring installation. Roofing and the exterior shell of the structure must be finished and weather tight with doors and windows installed. The wall coverings should be in place and all painting completed—except for the final coat on the base molding. Room temperature and humidity should be consistent with year round conditions for at least one week prior to installation. When possible, install base molding after floor installation is complete.

HVAC MUST BE RUNNING WITH A ROOM TEMPERATURE OF BETWEEN 60°F TO 80°F AND RELATIVE HUMIDITY OF BETWEEN 30 AND 50%.

CLIMATE CONTROL

If heating and/or air conditioning with proper humidity controls are in operating condition, they need to be turned on. If it is not possible for the permanent system to operate, a temporary system that provides proper temperature and humidity conditions must be in place and remain in place until permanent climate control is operational.

INSTALL FLOORING LAST

Hardwood floor should be the last trade in the house (before base boards are installed). All concrete, masonry, plastering/drywall, texturing, and painting/primer coats should be completed beforehand. Covering the floor while wet trades are in the house can lead to moisture condensation on the protective paper. Moisture can

pull into the paper or be trapped under the surface of materials used to cover the floor. Paper coverings also allow dents and scratching to occur.

COLOR VARIATION

Hardwood flooring is a natural product and color variations are to be expected. For best visual effect, shuffle planks from several cartons and do not install boards varying greatly in color next to one another. Dry rack the material with 3-4 cartons and make sure that the homeowner/end user approves the material before installing the floor. Once a floor is installed is it deemed acceptable and will not be warranted for any color variation, texture, gloss, finish claims. Always install the floor when the homeowner/end user is present.

ACCLIMATION

As relative humidity varies in different parts of the country, acclimation of the flooring prior to installation is the most important precaution to take in order to insure a successful installation. Proper acclimation is necessary to adapt the moisture content of the flooring to the conditions of your environment. Improper acclimation can cause the floor to buckle and/or the boards to shrink or cup after installation.

SUB-FLOOR PREPARATION

Sub-floor must be level, dry and free of imperfections. An uneven sub-floor will make the floor feel unstable and cause premature damage.

READ THESE INSTRUCTIONS THOROUGHLY BEFORE BEGINNING INSTALLATION. IN ADDITION TO THESE INSTRUCTIONS, WE RECOMMEND THAT THE Installer FOLLOW ALL INSTALLATION GUIDELINES AS SET FORTH BY THE NATIONAL WOOD FLOORING ASSOCIATION.

FLOORING MATERIAL SHOULD BE INSPECTED PRIOR TO INSTALLATION

Responsibility for the suitability of manufacturing flooring and accompanying products for each individual installation cannot be assumed by Manufacturer, since Manufacturer has no control over the Installer's proper application. Should an individual plank be doubtful as to appearance or dimension the Installer should not use this piece. Manufacturer will send replacement in a timely fashion.

PRE-INSTALLATION JOB SITE REQUIREMENTS

Manufacturer cannot be held responsible for site conditions. Carefully examine the flooring prior to installation for grade, color, finish and quality. Ensure adequate lighting for proper inspection. If flooring is not acceptable, contact your supplier immediately and arrange for replacement. Manufacturer will not accept responsibility for flooring installed with visible defects. Prior to installation of any flooring, the Installer must ensure that the job site and sub-floor meet the requirements of these instructions. Manufacturer

is not responsible for flooring failure resulting from unsatisfactory job site and/or sub-floor conditions.

Flooring should be one of the last items installed in any new construction or remodel project. All work involving water or moisture should be completed before flooring installation. Water and wood do not mix. Installing flooring onto a wet sub-floor will most likely cause cupping, tip & edge raising, telegraphing of core and subsequent gapping.

Room temperature and humidity of installation area should be consistent with normal, year-round living conditions for at least one week before installation of flooring. Optimum room temperature of 70 °F and a humidity range of 30-50% is recommended during installation. Humidity levels below 30% will most likely cause movement in the flooring, including gapping between pieces and possible cupping and checking in the face.

Store the flooring in the installation area for 72 hours before installation to allow flooring to adjust to room temperature. Do not store the boxes of flooring directly on concrete. These floors need adequate acclimation for moisture equalization prior to installation. Shuffle the boards for best visual mix of lengths and color.

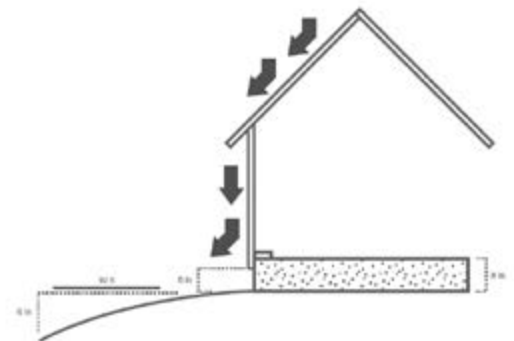

EXTERIOR CHECKS

1. Is exterior soil elevation 6" below edge of flashing?
2. Does exterior slope away from foundation at a rate of 6" drop in 10' for soft-landscaped areas and 3" drop in 10' for hard-paved areas?

NOTE: Proper drainage away from the structure is absolutely critical to ensure weather-tight conditions and crucial to proper hardwood flooring performance. If structure is near a hill, the lot should be graded with a swale to move moisture off the lot and prevent it from coming in contact with the foundation.

CRAWL SPACE VENTILATION

Crawl space earth (or thin concrete slab) should be covered 100% by a vapor retarder of black polyethylene (minimum 6 mil) or any recommended puncture-resistant membrane, such as Class C meeting ASTM D1745. Check local codes for any additional requirements.

Size of available vents should equal to 1.5% of the square footage within the crawl space. Relative humidity should be consistent with interior of home. Moisture content of sub floor should not vary more than a 2% MC from the top of the sub floor to the bottom.

It may be necessary to install temperature/humidity activated exhaust fans to create more air movement in the crawl space. Uncontrolled humidity and moisture in crawl space will lead to mold and damage to the structure, as well as the hardwood floor. In these events, a contractor specializing in dehumidifying systems will need to be contracted to keep crawlspace humidity



within proper norms. This is more likely in high humidity areas.

Ensure that clothes driers are properly vented to the outside of the foundation. Check for signs of plumbing, both pressurized and non-pressurized/drain leaks.

NOTE: Completely sealed crawlspaces (no exterior cross-ventilation) require a dehumidification system as part of the sealed crawlspace design.

BASEMENT MOISTURE & HUMIDITY CONTROL

Basements should be completely weather tight and have proper drainage away from the foundation walls in place to ensure that the basement remains dry.

1. Rain gutters must be in place to carry moisture away from the house. French drains are recommended, and basement walls should be properly sealed.
2. Relative humidity of basements should not be more than 10% higher than the upper floors.
3. Humidity control of the basement is vital to help control mold and prevent damage to the structure and hardwood flooring.
4. Basement walls should be inspected for cracks and excessive moisture content.
5. Drains must be placed at basement windows.
6. Direct sprinklers and irrigation systems away from the foundation. Sprinklers spraying the foundation edge can lead to moisture intrusion into structure. Drip irrigation systems for plant beds is recommended.



SUB FLOOR MOISTURE TESTING CONCRETE

Since wood flooring is not compatible with wet conditions, Manufacturer does not warrant against moisture related issues or related damage under warranty. (See Manufacturer Maintenance & Warranty Guides). This is an industry standard, and Manufacturers do not offer moisture warranties. However, moisture warranties are offered by various adhesive manufactures.

NOTE: Due to the porous nature of concrete, vapor emissions are subject to change over the lifetime of the installed floor. Slab moisture emissions are a common cause of damage to hardwood floors. Due to the potential for concrete moisture emissions to increase/decrease over time, and the absence of moisture warranties for wood flooring, choosing an adhesive system that includes moisture abatement properties is prudent.

Adhesive Manufacturers offer moisture warranties for moisture abatement systems that will be conditional. Follow their directions closely to ensure compliance and full warranty coverage. Proper spread rate and coverage are very important. Use proper trowel size and replace trowels at the recommended square footage the adhesive Manufacturer requires to ensure proper application thickness.

Some Adhesive Manufacturers offer adhesive/moisture abatement systems that do not require pre-installation testing of the slab to maintain a moisture warranty. Check with Adhesive Manufacturer to confirm which products they offer, that allow installation without pre-checking/testing the slab.

ADDITIONAL NOTE: Manufacturer makes no guarantees regarding the performance of any adhesive/vapor abatement system.

The Installer is fully responsible for proper installation, and the moisture warranties are fully the responsibility of the adhesive moisture abatement system Manufacturer chosen for the job.

NWFA & INDUSTRY STANDARDS

The NWFA (Industry standard) uses the following test methods to determine optimal conditions for installation and performance of a hardwood floor. Some Adhesive Manufacturers offer systems that create a vapor barrier to protect the wood flooring from moisture emissions coming up through the slab. Many Adhesive Manufacturers require the tests listed below to be performed prior to installation of the floor. Carefully read and follow the adhesive Manufacturer's instructions.

CALCIUM CHLORIDE: ASTM F1869

Under ideal conditions, the slab should not be emitting more than 3 lbs. per 1,000 square feet per 24 hour period. Carefully follow the instructions in the test kit to ensure that you get accurate results.

NOTE: The slab emissions can vary based on soil humidity and room temperature. Consult adhesive Manufacturer's directions for the moisture abatement system they recommend.

HUMIDITY PROBE & DIGITAL METER: ASTM F2170

This test determines the amount of humidity in the slab. This is an effective way to determine a slab's potential for emitting moisture. Follow all meter Manufacturer's guidelines for performing testing. Under ideal conditions, the slab readings should be 75% RH.

CAUTION: Post Tension slabs require special care to avoid cutting cables in slab. Cutting post tension cables can cause serious structural damage and potential fatalities.

New concrete slabs require a minimum of 60 days drying time before covering them with a wood floor. The slab must be fully cured. Slab must be comprised of Portland-based mix with 2,500 PSI of compressive strength.

Sub floor Preparation CONCRETE

For glue down application over gypsum or lightweight concrete, the same 2,500 PSI rating is required. (See floating installation section for installation over lightweight substrates).

Note: Some adhesive systems have primers and adhesives that are suitable for use over gypcrete or lightweight concrete, and may have different PSI compressive strength requirements. Adhesive Manufacturer is responsible for performance of their systems over gypcrete or lightweight concrete. Remove all paint, oil, existing adhesives, wax, grease, dirt, sealers, and curing compounds. Do not use solvent-based strippers under any circumstances, as residual solvents can prevent the satisfactory bonding of the vapor barrier and adhesive systems. It is important to

ensure a long-lasting bond between the adhesive, the concrete, and the boards.

FOLLOW ALL ADHESIVE APPLICATION INSTRUCTIONS.

Industry standard practice is to use a sanding system with 20 grit # 3½ open-face paper to remove loose, flaky concrete. For heavy surface contamination, it may be necessary to bead blast the concrete surface.

NOTE: Adhesive Manufacturers generally recommend prep fillers and patches to repair concrete substrates that are compatible with the adhesive system to be used. Make sure you use the prep products that are recommended by the Adhesive Manufacturer. Sub floor tolerance for a flat surface is 3/16" within a 10' radius and 1/8" in a 6' radius. These are industry standards established by NWFA. Use a straight edge to determine if sub-floor requires grinding or filling. NOTE: A quarter is approximately 1/16" thick and can be used as a thickness gauge. Grind high spots and fill low spots with Adhesive Manufacturer's recommended filler.

NOTE: Use the filler recommended by the Adhesive Manufacturer.

CAUTION: ASBESTOS

State and Federal agencies have determined that asbestos is a respiratory carcinogen. Avoid sanding or scraping of old vinyl, linoleum and VCT as they may contain asbestos. Take proper precautions and contact an asbestos abatement company to remove any old vinyl or vinyl tile floors containing asbestos. Cut-back adhesive and other types of adhesives can also contain asbestos.

CLEAN THE SUB FLOOR

After all prep work is completed, sweep and/or vacuum the sub floor. Dust and dirt can affect the adhesive or vapor barrier's ability to adhere to the slab. Installing over Existing Floor Coverings on Concrete Perimeter-glued resilient vinyl, VCT and rubber tiles are not acceptable underlayments and must be removed.

Terrazzo, tile, and full spread glue-down vinyls that are dry, structurally sound, and level (as described above) may be suitable as a sub floor for installation. See adhesive Manufacturer's guidelines. Manufacturer is not responsible for performance or suitability of existing flooring products that are not removed from concrete. As indicated above, the surface must be sound, tight, and free of paint, oil, existing adhesives, wax, grease and dirt.

Terrazzo and ceramic tile must be sufficiently scuffed to assure adhesion. Portland based products must be used to comply with flatness requirements of 3/16" in a 10' radius or 1/8" in a 6' radius. See adhesive Manufacturer's guidelines.

Existing vinyl, tile, or terrazzo are not considered to be vapor barriers, and can still transmit unacceptable moisture levels to hardwood flooring. Existing hardwood flooring must be removed prior to the installation of a new wood floor on concrete.

SUB FLOOR PREPARATION WOOD

Wood sub floors need to be well nailed or secured with screws. Nails should be ring shanks, and screws must be counter-sunk. The wood sub floor needs to be structurally sound (i.e. without loose boards, vinyl, or tiles). Sub floor tolerance for a flat surface is 3/16" within a 10' radius and 1/8" in a 6' radius. These are industry standards established by NWFA.

Engineered sub floor panels, must be ANSI-rated plywood of specified thickness to meet joist spacing specifications listed below, or sound solid lumber sub floor that is a minimum of 3/4" thick and dry.

1. For panel products sub flooring, check for loose panels and re-nail or screw down loose panels securely. Nails and screws must be countersunk.
2. Ensure that there is proper expansion space (1/8") between the panels. If panels are not tongue and groove and do not have sufficient expansion space, it may be necessary use a circular saw to create the specified space. Do not saw through joints on tongue and groove sub floors.
3. Check for delamination or damaged areas to sub floor and repair those areas as needed.
4. Make sure sub floor is free of debris before beginning installation.
5. Acceptable Panel Sub floors: Truss/joist spacing will determine the minimum acceptable thickness of the panel sub flooring.

A. Truss/joist spacing of 16" (406cm) o/c or less, the industry standard for single panel sub flooring is a minimum of 5/8" (19/32", 15.1mm) CD Exposure 1 plywood sub floor panels 4' x 8' panels.

B. Truss/joist spacing of more than 16", up to 19.2" (488mm) o/c, the standard is a minimum 3/4" (23/32", 18.3mm) tongue and groove CD Exposure 1 Plywood 4' x 8' sheets glued and mechanically fastened.

C. Truss/joist spacing of more than 19.2" (488mm) o/c up to a maximum of 24" (610mm) requires a minimum 7/8" tongue and groove CD Exposure 1 plywood sub floor panels, 4' x 8' sheets, glued and mechanically fastened.

JOIST CROSS-BRACING

A sub floor that is not thick enough to support the span of the joists will cause unacceptable sub floor deflection. An alternative to adding additional plywood on top of the sub floor would be to cross-brace between the joists. The cross-bracing would be done at the appropriate distance on center to meet specification and bring the deflection within proper tolerance.

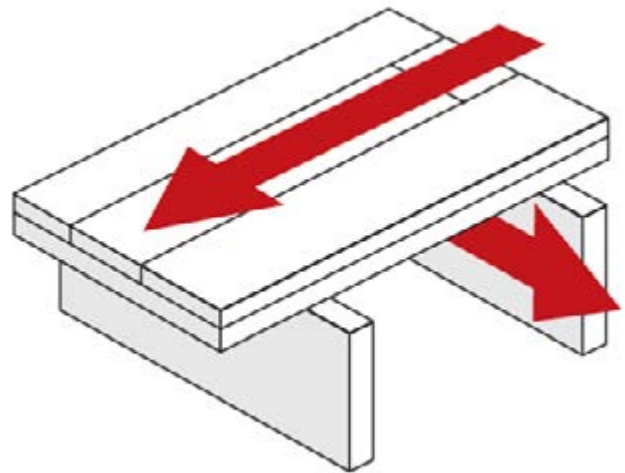

Check with the joist or truss Manufacturer to determine if cross-bracing is allowed with that system. Should it not be compatible with the joist or truss Manufacturer, sheathing the sub floor with a second layer of CD or better grade plywood would then be the only option. (See double layer sub floors section).

DIRECTION OF INSTALLATION IN RELATION TO JOIST DIRECTION.

The best application is at a 90° angle across the joists. This provides for best stability of the floor. As an alternative, the floor can be installed at a 45° angle to the joists. The floor cannot be installed in the same direction as the joists without installing an additional sheet of plywood on top of the existing wood sub floor.

DOUBLE LAYER SUB FLOORS

When sub floor does not meet thickness standards for span between joists, a second layer of plywood is required to stiffen sub floor.

The second layer should consist of nominal 1/2" (15/32", 11.9mm) CD exposure 1 plywood sub floor panels, 4' x 8' sheets, depending on how much correction of deflection between joists is necessary.

The top layer of plywood should be offset by 2' from joints in first layer of sub floor, and installed in the opposite direction to the bottom sub floor panels. Glue top and bottom layer together with construction adhesive and screwing in to the truss/ joist system every twelve inches. Additionally, nail (ring shank) or staple layers together on a minimum 12" grid pattern.

EXISTING WOOD FLOOR –ON WOOD SUB FLOOR

When installing over an existing solid hardwood floor already attached to the wood sub floor, ensure that the existing floor is sound and firmly attached to sub floor. Install material at a 90° right angle or 45° angle (across grain) of existing hardwood floor.

NOTE: Do not install in the same direction as existing floor. Do not install over wood flooring glued to concrete.

CEMENTITIOUS PATCH - WOOD SUB FLOOR

Do not use cement-based patch to correct any wooden sub floor problems in preparation for nail down. In the event of moisture, determine source, eliminate, and allow sub floor to dry. If sub-floor is less than above specified thickness, or sanded to thickness less than specified see the above standards for top sheeting.

NOTE: Particle board sheeting of existing wood sub floor and Portland based leveling compounds are acceptable for glue-down or floating applications only (they are NOT suitable for nail-down applications).

ACCLIMATION

Wood flooring is a hygroscopic material subject to dimensional change as a result of variations in moisture, temperature, and humidity within the surrounding environment. Wood flooring simply needs to reach a moisture content level in equilibrium with the surrounding environment (EMC) **IN WHICH IT WILL BE INSTALLED, AT OR NEAR NORMAL LIVING CONDITIONS (Between 30 –50% RH).** The process of reaching this equilibrium is defined as acclimation, which allows the wood to properly adjust itself to the normal living conditions within the structure; that is, the temperature, humidity conditions, and moisture content that will typically be experienced once the structure is occupied and stable indoor climate control is exercised.

NORMAL ENVIRONMENTAL CONDITIONS MUST BE MET TO ENSURE OPTIMAL PERFORMANCE.

When heating and ventilating systems are designed and working to maintain an interior relative humidity level between 30% and 50%, and a temperature between 60 and 80°F year round. At manufacturing, flooring is dried to a content of between 8–10% and maintained at a relative humidity environment ranging from 30% to 50%. Ideally, the installation environment will be maintained at the same humidity range.

ACCLIMATION OF ENGINEERED PRODUCTS

Manufacturer Manufacturers material to mimic what would be found in a 30–50% relative humidity environment. Consequently, it is pre-acclimated to the green zone conditions found in the chart below.

To maintain proper relative humidity levels, above 30% and below 50% RH, use of the following equipment is recommended. Failure to maintain humidity range can result in damage to the wood floor.

Air conditioner (of proper size and in working order)

Dehumidifier (if required) to prevent relative humidity levels above 50% Whole House Humidifier (of proper size and in working order) (if required) to maintain relative humidity levels above 30%.

Acclimation is NOT SIMPLY A MATTER OF TIME! It is based on what the living conditions in the house will be. If flooring is acclimated outside of the green zone from the chart above excessive movement and damage to the floor will occur. Check Manufacturer Climate Control & Radiant Heat Guide for more details.

NOTE: The space needs to be acclimated to the engineered wood flooring, more than the other way around. Remember: 30 to 50% RH and 60° to 80°F is the target for indoor conditions.

PRE-INSTALLATION SUB-FLOOR REQUIREMENTS

All Sub-floors must be:

- Dry and will remain dry: Sub-floor must remain dry year-round. Moisture content of wood sub floors must not exceed 11%. Concrete must be tested for moisture content using the Anhydrous Calcium Chloride test method, a non-invasive moisture meter, or a pin/probe moisture meter.
- Structurally sound
- Clean: Thoroughly swept and free of all debris (If being glued down, sub-floor must be free of wax, grease, paint, sealers, & old adhesives etc., which can be removed by sanding)
- Level: Flat to 3/16" per 10-foot radius

Wood sub-floors must be dry and well secured. Screw every 6" along joists to avoid squeaking. If not level, sand down high spots and fill low spots with a Portland Based leveling patch.

Concrete sub-floors must be fully cured, at least 60 days old, and should have minimum 6-mil polyfilm between concrete and ground. Sub-floor should be flat and level within 3/16" per 10' radius. If necessary grind high spots down and level low spots with a Portland leveling compound. All concrete should be tested for moisture prior to installation using the Anhydrous Calcium Chloride test method, a non-invasive moisture meter, or a pin/probe meter. When using a Calcium Chloride Test, the result must not exceed 3 lbs per 1000 sq. ft. in a 24 hour period.

A moisture test must be performed to ensure that the concrete slab is dry. Remember, a concrete slab on/ below grade that measures dry today may become moist in the future due to rising groundwater. Installing a moisture barrier now may be viewed as an insurance policy against concrete becoming wet in the future. Manufacturer is not responsible for site related moisture issues.

For additional protection, you may want to consider applying moisture barrier compound system.

INSTALLATION TOOLS

For all installation methods:

- Tape measure
- Tapping block (trimmed piece of flooring)
- Pencil
- Pry bar or pull bar
- Chalk line
- Wood or plastic spacers (3/8")
- Crosscut power saw
- 3M Blue Tape (DO NOT ADHERE TO OIL FINISHED FLOORS)
- No mineral spirits for all oiled finish floors

For glue-down installation method, you'll also need:

- Recommended flooring adhesive
- Trowel per flooring adhesive Manufacturer's recommendations.

Acceptable sub-floor types:

- CDX Underlayment Grade Plywood at least 1/2" thick (USE OF OSB SUBFLOOR CAN CAUSE POTENTIAL MOVEMENT AND SQUEAKING NOISE, WHICH IS NOT A MANUFACTURER DEFECT)
- Underlayment grade particleboard (floating/glue-down only)
- Concrete slab (floating/glue-down only)
- Existing wood floor
- Ceramic tile (floating/glue-down only)
- Resilient tile & sheet vinyl (floating/glue-down only)

STARTING YOUR INSTALLATION

Make sure sub-floor is tested for moisture first and is properly prepared. Since natural flooring expands with any increase in moisture content, always leave at least an expansion space between flooring and all walls. The expansion range depends on the thickness of the floor and any other permanent vertical obstructions, (such as pipes and cabinets).

This space will be covered up once you reapply base moldings around the room. Use wood or plastic spacers during installation to maintain expansion space.

Work from several open boxes of flooring and "dry lay" the floor before permanently laying the floor. This will allow you to select the varying grains & colors and to arrange them in a harmonious pattern. It also allows you the opportunity to select out very dark/light pieces for use in hidden areas in order to create a more uniform floor. Remember, it is the Installers' responsibility to determine the expectations of what the finished floor will look like with the end user first and then to cull out pieces that do not meet those expectations.

Begin installation next to an outside wall. This is usually the straightest and best reference for establishing a straight working line. Establish this line by measuring an equal distance from the wall at both ends and snapping a chalk line. The distance you measure from the wall should be the width of a plank plus about 3/8" for

expansion space. You may need to scribe cut the first row of planks to match the wall in order to make a straight working line if the wall is out of straight.

You may want to dry lay a few rows, (no glue or nails), before starting installation to confirm your layout decision and working line. When laying flooring, stagger end joints from row to row by at least 8". When cutting the last plank in a row to fit, you can use the cut-off end to begin the next row. If cut-off end is 8" in length or less, discard it and instead cut a new plank at a random length and use it to start the next row. Always begin each row from the same side of the room. To draw planks together, always use a tapping block (a short piece of flooring), as tapping the flooring itself will result in edge damage. For best results, flip the tapping block upside down and use the groove edge to tap the tongue edge of the plank being installed. Fit end joints tightly together before tapping long edges together. When near a wall, you can use a pry bar to pry close the side and end joints. Take care not to damage edge of flooring. DO NOT ADHERE TAPE OF ANY KIND TO OIL FINISHED FLOORS.

FOR STAPLE INSTALLATION ALL ENGINEERED

HARDWOOD WIDTHS USE GLUE ASSIST. Before you begin using the following instructions, please refer to the Pre-Installation Job Prep information above.

NOTE: Our products are not warranted against squeaking, popping or crackling when using staple-down or nail-down installation methods. Some squeaking, popping or crackling is normal and possible when using staple-down or nail-down installation methods. These symptoms may be aggravated in arid areas or during dry conditions.

SET UP AND USE OF PNEUMATIC STAPLERS & NAILERS (GLUE ASSIST IS REQUIRED FOR ALL SIZES THAT ARE INSTALLED BY NAIL/STAPLE):

Minor occasional noises within the flooring are inherent to all staple/nail-down installations and can change as environmental changes occur. This is not a manufacturing defect and is therefore not covered under our warranties. You can help reduce squeaking, popping, and crackling by being sure that the sub-floor is structurally sound, does not have any loose decking or joists, and is swept clean prior to installation. You should also be sure that your stapler or nailer is setting the fastener properly, not damaging the planks, and that you are using the correct nailing schedule. When used improperly, staples or cleats can damage wood flooring. If the tool is not adjusted properly the staples/cleats may not be positioned at the proper angle and cause blistering, peaking, squeaking, or crackling of the floor. Some models may require the use of an adapter to adjust for proper thickness. Test the tool on a piece of scrap material first - set the stapler/ nailer flush on the tongue side of the plank and install a staple/cleat.

Be sure not to over-drive the fastener past the nail slot, this can lead to a condition known as a telegraphing fastener. A telegraphing fastener is the visible effect of

excessive pressure being placed on the wood fibers which causes the appearance of a bump to occur just above the fasteners. This condition becomes most apparent when natural or artificial light reflects across the surface of the floor causing the bump to become visible to the eye. This condition can sometimes be difficult to see, so make sure to thoroughly examine the first few rows of flooring to make certain telegraphing does not exist. The Manufacturer does not warrant against this condition since telegraphing fasteners are not manufacturing related. If you should encounter this condition immediately stop the installation and contact your local distributor or Manufacturer of the nailer for technical advice. It is essential that the flooring Installer make sure that the nailer/stapler is properly adjusted for the particular floor that is being installed i.e. the fastener(s) MUST enter the nail slot at the correct angle and height, do not over-drive the fastener(s) so as not to cause damage to the board e.g. telegraphing fasteners, broken or split tongues, peaking, squeaking, or crackling noises to occur.

All engineered floors are required to be installed with either a full spread adhesive, rated for the proper width of the material being installed, or if nailing or stapling, a glue assisted installation.

Air Pressure Settings

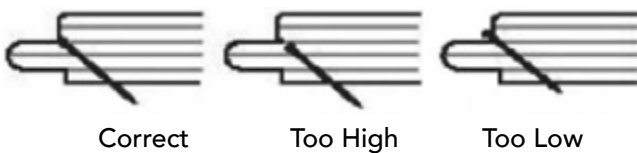

Full Spread Installation: You must account for moisture in any installation. Consult the Manufacturer or the NWFA for concrete installations. For installations over a sub floor, prime the floor with an approved adhesive primer with moisture vapor retarder. This will increase adhesion and provide the proper moisture transfer from the sub-floor. Use an approved hardwood flooring adhesive for the width to be installed with the proper trowel for the material to be installed. Follow adhesive Manufacturers' installation procedures.

Glue Assisted Installation: You must account for moisture in any installation. In the event the sub-floor is not within acceptable moisture tolerance range. Two suggested ways to provide a moisture vapor retarder is to install an underlayment paper. Cut a 1/2" channel, in the paper perpendicular to the direction of the floor to be laid, every 12" on center. A second option is to roll on a coat of moisture barrier over the entire sub-floor to create a moisture retarder. During installation of the wood you can then run a minimum 1/4" bead of approved adhesive (ie Bostik's Best in a caulking tube) every 12" on center perpendicular to the direction of the wood. Use a normal nailing pattern for the dimensions of the wood installed per NWFA installation procedures.

During installation of the wood you can then run a minimum 1/4" bead of approved adhesive (ie Bostik's Best in a caulking tube) every 12" on center perpendicular to the direction of the wood. Use a normal nailing pattern for the dimensions of the wood installed per NWFA installation procedures.

Part I: Acceptable Job site Conditions and Job site Checklist

A. Refer to NWFA Installation Guidelines Chapter 1, Job site Conditions.

Part II: Acclimation Guidelines

A. Refer to NWFA Installation Guidelines Chapter 2, Acclimation and Conditioning of Wood Flooring.

Part III: Appropriate Grade Levels

A. Engineered wood floors can be installed successfully on, above or below grade level. Engineered wood floors can be installed directly to a concrete or wood sub-floor.
 B. The entire flooring level is considered to be below grade where soil is present along any perimeter wall and is more than 3" above the installed wood flooring level. Ground should be sloped away from the house for proper drainage. (Check local building codes. Local building codes prevail. Follow local building codes.)

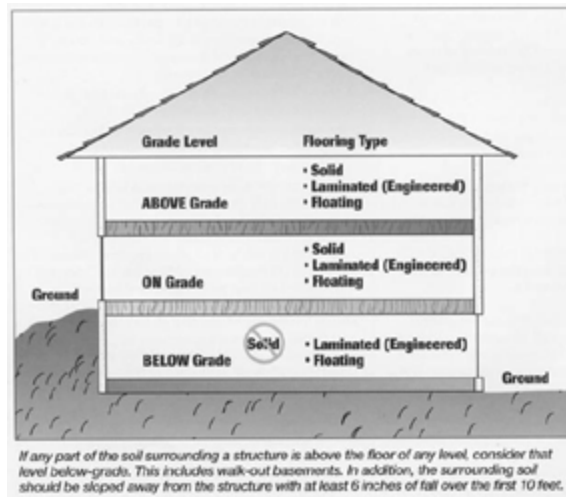

Part IV: Sub-floors – Wood Joist Systems

A. Refer to NWFA Installation Guidelines Chapter 4, Wood Sub-floor Guidelines.

Part V: Sub-floors – Concrete Slab

A. Refer to NWFA Installation Guidelines Chapters 5, Concrete Sub-floor Guidelines, and Chapter 6, Installing a Sub-floor Over Concrete.

Part VI: Engineered Flooring Installation Methods

A. Engineered wood flooring can be installed directly to screeds, provided the engineered flooring is a minimum of 3/4" thick. For engineered flooring less than 3/4" thick,

the screed system must be overlaid with proper sub-flooring. Refer to NAWFA Installation Guidelines Appendix I, Installation Over Screeds.

B. Note on random-width plank.

1. Random-width plank is laid out with alternating courses varying by widths. Start with the widest board, then the next width, etc., and repeat the pattern.

C. Choose a starting wall.

1. Choose a starting wall according to the most aesthetically or architecturally important elements in the room, taking into consideration fireplaces, doors, cabinets and transitions, as well as the squareness of the room. The starting wall will often be the longest unbroken wall in the room.

D. Glue-down engineered strip and plank.

1. There are several different ways to start the installation of glue-down engineered wood flooring. The following has proven successful. However, where instructions differ from Manufacturer recommendations, Manufacturer recommendations prevail.
2. Test the substrate for moisture according to appropriate moisture testing procedures in Chapter 3, Moisture Guideline and Vapor Retarders. Excessive/elevated moisture should not be present. The sub-floor should be within acceptable moisture content as per adhesive and wood Manufacturer's recommendation before installing.
3. Expansion space should be left around the perimeter in accordance with the Manufacturer's recommendation.
4. Snap a working line parallel to the starting wall, the width of the board, plus the tongue and recommended expansion space.
5. Install a starter board along the edge of the working line and begin installation. Alternatively, lay one row of plank in the adhesive along the length of the working line.
6. Follow Manufacturer instruction for tongue and groove direction and placement.
7. Use an adhesive approved by the flooring Manufacturer. Follow the installation procedure recommended by the adhesive Manufacturer, which includes sub-floor moisture content, spread rate, trowel size, open time, working time and flash time as necessary. Spread the adhesive as instructed up to and along the working line.
8. Visually inspect boards for any defects prior to installation. Verify that homeowner has seen product

and approves proceeding with installation of the floor.

9. Always work from multiple boxes simultaneously and blend the boards throughout the installation. This is especially important with mixed production dates. We have very good color consistency, and mixed production dates are acceptable for installation. Working from multiple boxes/production dates helps achieve a good blend of color.
10. Distribute lengths, avoiding "H" patterns and other discernible patterns in adjacent runs. Stagger end joints of boards row to row a minimum of 6" for strip flooring, 8"-10" for 3" to 5" plank, and 10" for plank wider than 5". (See Figures 8-1 and 8-2.)
11. It's recommended by the Manufacturer for urethane finish to use tape or tensioner to maintain a tight floor.
12. For oil finish floors, do not use any tape. Use tensioners or strap as in the picture below to hold the planks together.
13. If recommended by the Adhesive Manufacturer, roll the floor with the proper roller.

Figure 8-1 Stagger End Joints

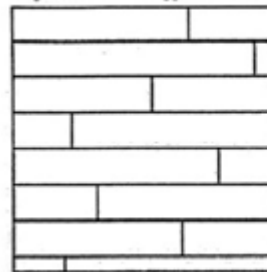
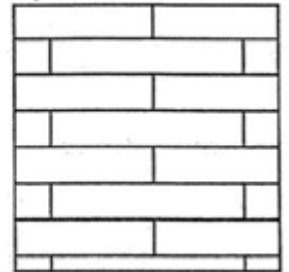
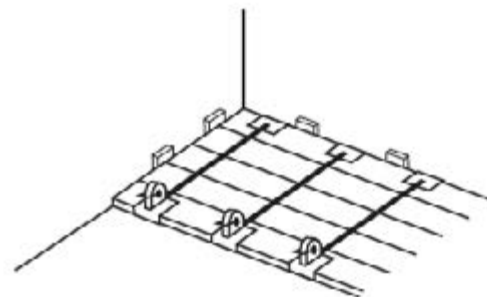

Figure 8-2 Avoid "H" Joints



E. Mechanically fastened strip and plank.

1. If necessary, add a vapor retarder.
2. Snap a working line parallel to the starting wall, allowing expansion space as specified by the Manufacturer.



3. Lay one row of plank along the entire length of the working line.

4. 4. Top-nail and blind-nail the first row (hand-nail if necessary), using appropriate fasteners. Denser species may require pre-drilling. Each succeeding row should be blind-nailed wherever possible.
 - A. Typical: Narrow crowned (under 3/8") 1"-1½" staples or 1"-1¼" hardwood flooring cleats designed for engineered flooring, spaced as recommended by the Manufacturer.
 - B. Typical: Every 3"-4" with staples, every 4"-6" with cleats, and within 1"-2" of end joints. Use appropriate size fastener for top nailing first row, last row and any area where blind nailer will not fit.

5. Add each additional row of flooring. Distribute lengths, avoiding "H" patterns and other discernible patterns in adjacent runs. Stagger end joints at least three times the width of the boards, as product allows.
6. During installation of flooring pieces, push or gently tap boards flush to the previous row. Tap against the tongue; tapping the groove may damage the edge. To prevent damage to the finish, avoid tapping the face of the board with a rubber mallet.

F. Floating engineered flooring.

1. 1. Sub-floor flatness is critical to the success of a floating floor installation. (Refer to NWFA Installation Guidelines Chapter 4, Wood Sub-floor Guidelines, and Chapter 5, Concrete Sub-floor Guidelines.)
2. 2. Test the substrate for moisture according to appropriate moisture testing procedures in Chapter 3, Moisture Guideline and Vapor Retarders. Excessive/elevated moisture should not be present. The sub-floor should be within acceptable moisture content as per Manufacturer recommendation before installing.
3. 3. If necessary, add vapor retarder. (Refer to NWFA Installation Guidelines Chapter 3, Moisture Guideline and Vapor Retarders, Part III, Acceptable Vapor Retarders Over Wood Sub-floors.)
4. 4. Expansion space should be left around the perimeter or in accordance with Manufacturer's recommendation.
5. 5. Typical: Sub-floors are covered with a resilient material, foam underlayment or cork. Follow Manufacturer's instructions for correct materials and thickness.
6. 6. Typical: Floating engineered flooring is edge-glued or edge-attached with a self-locking mechanism.

A. For edge-glued products, use a glue approved by the flooring Manufacturer.

- B. Apply glue at the spread rate to the side grooves and/or ends as recommended by the flooring Manufacturer.
7. Starter boards should be aligned with the groove side and end against the starting wall. Tapping block should be used against tongue only.
8. Stagger end joints per Manufacturer's recommendation.
9. You cannot float all Engineered Hardwood floors. Please contact the manufacture to confirm which products can be floated. Any 3/8" Thick and 5" Wide Engineered hardwood product cannot be floated.

GLUE DOWN INSTALLATION

Make sure sub-floor is tested for moisture content first and is properly prepared.

On concrete sub-floors, which are on or above grade (ground level), always assume the worst even if they measure dry. We recommend taking the following installation steps to ensure a trouble-free installation:

- Testing and documenting moisture content prior to installation
- Applying a sealer to the sub-floor as needed

Follow adhesive Manufacturer's instructions for proper trowel size, minimum temperature, adhesive set time and open times before beginning installation of flooring. Once the spread adhesive has setup sufficiently per adhesive Manufacturer's instructions, lay the first row of flooring with groove facing the wall, and continue laying flooring. Always check your working lines to be sure the floor is still aligned. Use tapping block to fit planks together but be careful not to let installed floor move on the wet adhesive while you are working. Always leave at least a 3/8" expansion space between flooring and all walls and vertical objects (such as pipes and cabinets). Use wood or plastic spacers during installation to maintain this expansion space. Remember to stagger end joints from row to row at least 8" apart.

When first section is finished, continue to spread adhesive and lay flooring section by section until installation is complete. Use a damp cloth to **IMMEDIATELY REMOVE ANY ADHESIVE** that gets on the flooring surface. If adhesive cannot be completely removed with a damp cloth, use the Manufacturer's recommended adhesive remover. Never let flooring adhesive dry completely on the finished surface. Walk each section of flooring in order to make sure it is well bonded to the sub-floor with the adhesive working time. Flooring planks on the perimeter of the room may require weight on them until adhesive cures enough to hold them down.

AFTER INSTALLATION

- Flooring should be one of the last items installed in a project. In order to protect the floors while other trades are finishing their work prior to final cleanup and turnover to the owner, use rosin paper. DO NOT use Blue Tape to adhere to the floor (blue tapes may

damage the finish). Clean the floor thoroughly before laying the rosin paper to ensure that no debris is trapped underneath. DO NOT USE plastic film or other non-breathing coverings as this can cause the floor to become damaged from humidity buildups.

- Remove expansion spacers and reinstall base and/or quarter round moldings to cover moldings to cover the expansion space.
- Dust mop or vacuum your floor to remove any dirt or debris.
- Install any transition pieces that may be needed (reducers, T-moldings, nosing. etc.).
- If using glue-down method, do not allow foot traffic or heavy furniture on floor for 24 hours

PROTECTION AND MAINTENANCE OF YOUR FLOOR

Lasting beauty can be achieved through purchasing a quality floor covering and providing proper on-going maintenance.

Fading: Natural floors contain organic pigments and are subject to fading when exposed to direct sunlight. Where possible, use drapes or other systems to protect your floor from excessive light.

Joints: Natural flooring reacts to the conditions in the environment. Natural flooring plank systems expand and contract in response to fluctuations in temperature and humidity. Controlling the environment, maintaining an adequate temperature and relative humidity will minimize the visible effects of normal contraction and expansion.

Optimum recommended temperature is 70°F and relative humidity is 30% - 50%. In very dry climates, the use of a humidifier might be necessary.

Photosensitivity: Hardwood floors are photosensitive and will change color as they age or are exposed to U.V. light. In some species the natural pigmentation will be lost and can develop a "bleached" appearance. In many exotic hardwood species (i.e. Tigerwood), the flooring develops a rich patina that will darken the appearance and enhance the natural beauty of the material. As this is a natural occurring phenomenon, accelerated with exposure to U.V. light, it is not considered a material defect and is excluded from coverage under the provisions of Manufacture's Limited Warranty.

Tips to Minimize Fading/Discoloration

- Avoid rubber-backed mats and rugs, as the backing may discolor your floor, recommend to use felt underlayment
- Change the location of your rugs periodically. Rearrange more frequently if they are placed in front of doors and windows.
- Use light filtering window treatments (i.e. blinds, drapes, window film) that will help prevent sunlight exposure.
- Rearrange furniture seasonally to allow the flooring

to darken and age uniformly.

If completing a flooring extension or board replacement after the original installation has been down for a period of time, the new flooring will have a lighter appearance. As the material is exposed to natural light, it should eventually blend in with the surrounding areas. However, due to the age of your flooring, surface wear (and/or) exposure to U.V. light, Manufacturer cannot guarantee replacement flooring will be a 100% match to your existing product.

Remember that color variation is to be expected with natural products. However, should an individual plank be doubtful as to appearance or dimension the Installer should not use this piece.

- **Follow the instructions on this installation guide as well as the guidelines listed out by the NWFA.**
- **For further detailed installation guideline, please refer to NWFA (www.nwfa.org)**
- **Oil finished floors require a cleaning process of OSMO wash and care or WOCA oil refresher depending on finish immediately after installation to bring out the beauty of your new floor and maintain warranty.**

Please refer to the Care and Maintenance for each collection to help maintain your floor properly.



Radiant Heat Installation

The following products from Casabella Hardwood are approved over radiant heat

- Angora
- Tradewinds
- Cheshire
- Countryside Birch
- Provincial
- Cedar Break
- Melbourne
- Handcrafted Hickory
- Portofino
- Ferno (except Salerno)
- Baroque
- American Relics (White Oak Only)
- Tuscany

The following products from Casabella Hardwood are not approved over radiant heat

- American Heritage
- San Pietro Maple
- Cimmaron
- Asian Walnut
- Adirondack
- Restoration Acacia
- Covelo Canyon
- Oak Handscraped
- Heritage Hickory
- Estate Hickory
- San Pietro Oak
- Ferno Salerno
- American Relics Hickory

If you have a product that is not on the list, please contact your sales representative.



INSTRUCTIONS FOR INSTALLATIONS OVER RADIANT HEAT SYSTEMS
Moisture and Humidity - Please read before beginning installation

Room temperature and humidity of installation area should be consistent with normal, year-round living conditions for at least a week before installation of wood flooring. Room temperature of 65 – 75 degrees Fahrenheit and a humidity range of 35% – 65% should be maintained during acclimatization, installation, and at all times afterward. Warning – humidity levels below these recommended levels will likely cause movement in the flooring, including gapping between pieces and possible cupping and checking in the face.

Casabella Hardwood cannot be held responsible for site conditions. Flooring formats, such as plywood based engineered wood flooring, are particularly susceptible to showing movement such as edge/shrinking and face checking from relative humidity below the stated minimum on site and/or tip raising and subsequent end shrinking if installed over a wet subfloor.

Important Notes:

Warranty is void if subfloor surface exceeds 81 degrees Fahrenheit.

Beware of “hot spots” where radiant heat enters the room, as they can be significantly hotter.

Prior to Installation of Wood Flooring:

Radiant heat must be installed and turned on- for a minimum of 3 weeks prior to installation of wood flooring.

Make sure to acclimate the new wood flooring in open packaging or out of packaging, in living areas of the home until moisture content falls within 4% points or less of the subfloor content.

Just prior to installation, radiant heat should be turned off or on the lowest setting for a minimum of 6 hours. This will prevent “hot spots” which could leave applicator marks or cause bubbles.

Glue Down Direct to Concrete

Radiant Heating pipes must be covered at least 3cm from the surface. The concrete must be:

Fully dry

Flat and level

Compact and Hard

Clean of Dust, Oil and grease

Free of cracks

Radiant Heat under Plywood Sub-Floor

It is recommended to glue and nail or staple down the floor when installed with radiant heating. Blind nail at a 45 degree angle into tongue with nails/staples approximately equal to the thickness of the engineered floor.

After Installation of Wood Flooring

Radiant Heat systems should be turned on and the temperature increased gradually over an approximate 10 to 14 day period. Regardless if the system is new or pre-existing, **NEVER** allow the radiant heat system’s temperature to change up or down more than 2 degrees Fahrenheit per day.

During the cold seasons when radiant heating is working at full power the humidity can get very low and the wood can become dried out. To prevent damage to the flooring (cracking or splitting) It is recommended that the relative humidity level remains between 35% and 65%. To ensure this, it is

Casabella® Hardwood

strongly advised to install room humidifiers or whole house systems, to ensure that the room does not become overly dry.

Casabella Hardwood Installation Guidelines are intended to offer general guidance as it relates to Casabella Hardwood and are NOT a replacement for a professional, certified installer. **All Casabella Hardwood flooring MUST be installed according to the National Wood Flooring Association's (NWFA) installation guidelines in order for the Warranty to be valid.** The most current publication of the NWFA guidelines are available to all NWFA members, and can be found at www.nwfa.org



Glue Assist Installation Requirement

Additional installation instructions for all solid floors over 4" wide & all engineered floors over 5" wide:

Glue Assisted Installation: You must account for potential moisture in any installation. All installations of the wood floors mentioned above require a glue assisted install. The two suggested ways to provide a moisture vapor retardant are:

1. Install an underlayment paper. Cut a ½" channel, in the paper perpendicular to the direction of the floor to be laid, every 12" on center. During installation of the wood run a minimum ¼" bead of approved adhesive (Mapei Ultrabond Eco 907 or a comparable product in caulking cartridge) every 12" on center perpendicular to the direction of the wood.
2. Roll on a coat of moisture barrier over the entire subfloor to create a moisture retardant surface. Use a normal nailing pattern for the dimensions of the wood installed per NWFA installation procedures.